

Bench meters

Simplify your pH analysis workflow with standard operating procedure recommendations

pH/ATC refillable epoxy-body electrode selection

Recommended Equipment

- Orion Lab Star PH111 pH/mV bench meter with stand
- Orion pH/ATC epoxy-body refillable electrode, cat. no. 9157BNMD
- pH buffers, typically pH 4.01, 7.00 and 10.01 buffers
- Electrode fill solution
- Electrode storage solution
- Deionized water
- Rinse bottle
- 50 mL beakers
- Waste beaker
- Lint-free lab wipes

Introduction

Accelerate and enhance development of your standard operating procedures (SOP) for pH analysis by utilizing these recommended steps for equipment setup, pH calibration and sample measurement.

The Thermo Scientific™ Orion™ Lab Star PH111 pH/mV bench meter is ideally suited for laboratories with users of varying levels of technical expertise and who require a simple-to-calibrate and use meter for routine pH testing. The Orion Lab Star PH111 pH/mV bench meters are capable of measuring pH or ORP simultaneously with mV and temperature. These meters offer a large, backlit display for clear viewing with small footprint to conserve laboratory bench space and they help ensure important data is preserved with a 500-point data log with date/time stamp that can also be exported to a printer or computer using the meter communication port.

This technical note uses a refillable, epoxy-body pH/ATC electrode with the pH meter, ideal for pH testing of common samples such as drinking water, tap water, buffers (non-TRIS) and general-purpose student use. Refillable electrodes offer the advantage of being easy to clean and refill when they become dirty, contaminated, or are stored for long periods. Epoxy electrodes are durable with a break-resistant body and built-in protector around the sensing bulb.

Electrode setup

The following setup procedure is recommended for the Thermo Scientific™ Orion™ Triode™ 3-in-1 pH/ATC Electrode, catalog number 9157BNMD, which is refillable and built with an epoxy-body. For other electrodes, refer to a different technical note or the electrode manual for recommended setup.

1. Remove any protective shipping materials from the pH electrode.
2. Rinse the pH electrode with deionized water to remove any salt deposits.
3. Uncover the electrode fill hole, located below the electrode cap. Add Thermo Scientific™ Orion™ pH Electrode Filling Solution, catalog number 900011, to the electrode, up to about 1 cm below the fill hole.

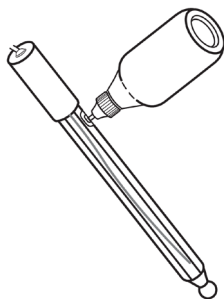

4. Soak the pH electrode in electrode storage solution for at least 30 minutes prior to use. The sensing bulb and reference junction must be immersed in the electrode storage solution.

Add fill solution to the electrode daily before use.

The electrode fill solution level must be above the electrode reference junction and at least one inch above the sample solution level to ensure a proper flow rate.

The electrode fill hole must remain open when taking measurements.

The sensing bulb must be hydrated to work properly. Always store the pH electrode in storage solution when not in use.

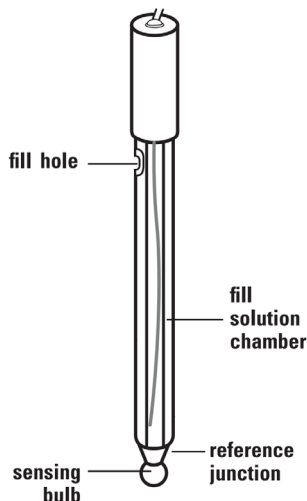

Meter setup – Electrode holder installation

The Thermo Scientific™ Orion™ Lab Star Series Electrode Stand with Meter-attached Bracket, catalog number LSTAR-ARM, can be installed on either side of the meter.

1. Unpack the base plate and stand with electrode holder from the meter box.
2. Turn the meter over, with the meter display facing down, on a clean dry surface.
3. Identify the side of the meter that the holder will be installed on and remove the screw between the circles on that side of the meter.
4. Align the base plate of the holder with the circles on the meter.
5. Replace the screw from step 3 to attach the base plate to the meter.
6. Turn the meter over, with meter display facing up.
7. Insert the stand with electrode holder into the metal post on the base plate.

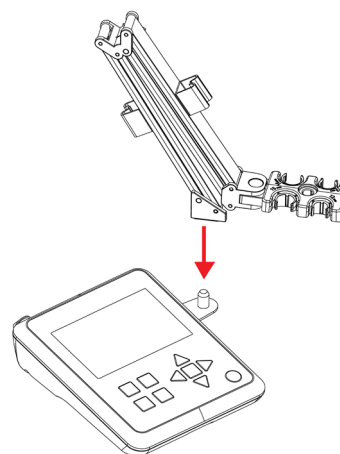

8. Place the electrode into the electrode holder. The 12 mm labeled slot is recommended for the Triode 3-in-1 pH/ATC Electrode.

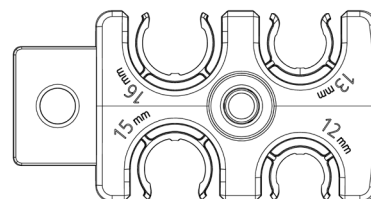

Meter setup – Power supply installation

The Thermo Scientific™ Orion™ Lab Star Universal Power Adapter, catalog number LSTAR-PWR, with US/Japan, Euro, UK/Singapore, Australia/New Zealand, and China wall plug plates is included with the meter.

Note: The power adapter plug has two prongs that allow the power adapter to be locked onto the meter. **These two prongs must be properly aligned when connecting it to ensure it is fully connected and locked onto the meter.**

Use of a surge protector or uninterruptible power supply (UPS) is recommended, as an unintended power surge of electricity may damage the meter and void the warranty.

1. Unpack the power supply provided with the meter.
2. Select the appropriate wall plug plate for the power outlet that will be used.
3. Slide the appropriate wall plug plate into the groove on the back of the power adapter.
4. Connect the power adapter to the meter input.
 - a. Locate the two slots on the meter power input.
 - b. Align the two tabs on the power adapter connector with the two slots on the meter power input.
 - c. Insert the power adapter connector into the meter power input and twist clockwise to lock the connection.
5. Connect the power adapter to a power outlet.

Meter setup – connections









1. Connect the assembled power adapter to the meter power input and wall outlet.
2. Connect the pH/ATC electrode to the meter using the BNC and ATC inputs.
3. If desired, connect a communication cable to the meter and external device. Use the included PC cable to connect the meter to a computer. Purchase the Thermo Scientific™ Orion™ Star A Series Compact Printer with cable, catalog number STARA-106, to connect the meter to a printer.



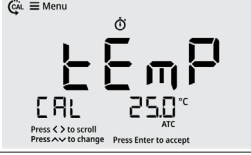
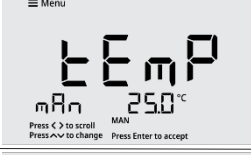



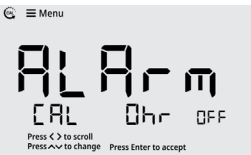
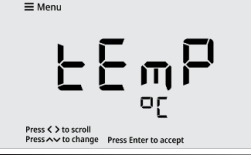

Meter setup – Meter settings

Select and set the appropriate meter settings in the meter Setup Menu:

1. Press the “Power” key to power on the meter.
2. In the Measure Mode, press the “Menu” key to access the meter Setup Menu.
3. The first Setup Menu item (View Logs, Data Log) will be shown. To scroll through the Setup Menu list, press the < or > key.
 - a. Press the > key to scroll to the second item.
 - b. Press the < key to scroll to the last item.
 - c. The list is cyclical, so continue to press the > key to scroll from the second item to third item, third item to fourth item, etc. and eventually from last item to the first item again.
4. To change a setting within a Setup Menu item, press the Δ or ∇ key.
 - a. For numeric value changes:
 - i. Press the Δ key once to increase the value by one least significant digit/unit.
 - ii. Press the ∇ key once to decrease the value by one least significant digit/unit.
 - iii. Press and hold the Δ key to quickly increase the value.
 - iv. Press and hold the ∇ key to quickly decrease the value.
5. Once a setting is changed, press the “Enter” key to save the change.
6. When viewing the data logs or calibration logs, press the “Menu” key to go back to the main Setup Menu list.
7. Press the “Measure” key at any time to exit the Setup Menu and return to the main measure mode.



#	Setup Menu	Default screen/setting
1	View Logs View up to 500 data log points and active pH, ORP and temperature calibrations.	
2	Log Export Type Set the export type as computer (CSV format), printer (list format) or off.	
3	Export All Logs Send all saved logs to the selected device. If Export Type is set to off, this menu will not be shown.	
4a	Temperature Calibration When an ATC probe is connected, use to perform a one-point temperature calibration, up to ±5.0 °C.	
4b	Manual Temp. Input When no ATC probe is connected, use to enter the sample temperature value, from -5 °C to 105 °C.	
5	Measure Mode Set the main measure mode to pH or relative mV (RmV) for ORP.	
6	pH Resolution Set the displayed pH resolution as 0.001, 0.01 or 0.1 pH units.	
7	Calibration Buffer Set Set the pH buffer set for automatic buffer recognition during pH calibrations. USA: 1.68, 4.01, 7.00, 10.01, 12.46 DIN: 1.68, 4.01, 6.86, 9.18, 12.46	
8	Read Type Set the Read Type as Continuous, Auto-Read or Timed to define how measurements are taken, saved and exported.	
9	Timed Interval When Read Type is set to Timed, set the time interval as 5 seconds to 60 minutes.	

#	Setup Menu	Default screen/setting
10	Calibration Due Alarm Set the time interval for the calibration due alarm from 0 hours (off) to 168 hours.	
11	Temperature Units Set the temperature units as °C (Celsius) or °F (Fahrenheit).	
12	Set Date Format Set the date format as month-day-year (MM.DD.YYYY) or day-month-year (DD.MM.YYYY).	
13	Set Date Value Set the month, day and year values. The Set Date Format setting is used for this menu.	
14	Set Time Value Set the time format as AM/PM or 24 hours and enter the time values.	
15	Audio Mode Set the audible beep on or off. The audible beep is used when an alarm is triggered.	
16	Sleep Mode Set the sleep mode on or off. When on, meter will sleep when no keys are pressed for 20 minutes. Press the "Power" key to wake the meter.	
17	Clear Data Use to erase all data logs or erase all calibration logs.	
18	Factory Reset Use to erase all data logs, calibration logs and settings and return the meter to its factory default state.	

pH calibration overview

For best results, periodic calibration with known, accurate and fresh pH buffers is recommended. Calibrate with pH buffers that bracket the expected measuring range and include a neutral buffer. For example, if samples will be pH 6.2 to 9.5, calibrate with pH 4.01, 7.00, and 10.01 buffers. Perform one to five point pH buffers. The non-volatile meter memory retains the most recent, active calibration data when powered off.

During the pH calibration, the meter will automatically recognize each pH buffer value using the pH buffer set selected in the setup menu and the mV signal measured by the pH electrode. Once the reading is stable, the meter will automatically display the buffer value at its measured temperature from the selected buffer set.

The following pH buffers are automatically recognized:

- USA: 1.68, 4.01, 7.00, 10.01, 12.46
- DIN: 1.68, 4.01, 6.86, 9.18, 12.46

If the mV value does not correspond to within $\pm 60\text{mV}$ of a pH buffer in the selected buffer set, once the pH reading is stable, the meter will display the theoretical pH value of the buffer according to the last pH calibration that was performed or, if no calibration has been performed, the meter will display the theoretical pH value of the buffer according to the Nernst equation.

USA Buffer Set

Temp. (°C)	pH 1.68 Buffer	pH 4.01 Buffer	pH 7.00 Buffer	pH 10.01 Buffer	pH 12.46 Buffer
0	1.667	4.000	7.111	10.320	13.474
5	1.668	3.999	7.082	10.249	13.245
10	1.669	3.999	7.056	10.182	13.030
15	1.672	4.001	7.033	10.121	12.828
20	1.675	4.005	7.013	10.064	12.638
25	1.678	4.010	6.997	10.013	12.460
30	1.683	4.016	6.984	9.967	12.293
35	1.688	4.024	6.974	9.925	12.137
40	1.693	4.033	6.967	9.889	11.991
45	1.700	4.044	6.964	9.858	11.855
50	1.707	4.057	6.963	9.832	11.728
55	1.715	4.071	6.966	9.811	11.609
60	1.724	4.086	6.973	9.794	11.499
65	1.733	4.103	6.982	9.783	11.396
70	1.744	4.122	6.995	9.777	11.301
75	1.755	4.142	7.011	9.776	11.213
80	1.766	4.163	7.030	9.780	11.130

The pH buffer values can be manually entered for each calibration point. If the pH buffer value needs to be manually adjusted, use the Δ or ∇ key to edit the value of the pH buffer at its measured temperature.

Press the "Cal" key to start and end the calibration. This allows pH calibrations to be performed using one to five points without having to program the number of points before starting the calibration.

Calibration preparation

1. Add about 30 mL of the pH 4.01 buffer to a 50 mL beaker and label the beaker.
2. Add about 30 mL of the pH 7.01 buffer to a 50 mL beaker and label the beaker.
3. Add about 30 mL of the pH 10.01 buffer to a 50 mL beaker and label the beaker.

pH Buffer Values vs. Temperature

The following tables list theoretical values for the Orion pH buffers at various temperatures. Actual values displayed on the meter during calibration may vary slightly due to rounding deviations from the actual pH and temperature measurements.

DIN Buffer Set

Temp. (°C)	pH 1.68 Buffer	pH 4.01 Buffer	pH 7.00 Buffer	pH 10.01 Buffer	pH 12.46 Buffer
0	1.667	4.000	6.984	9.455	13.474
5	1.668	3.999	6.952	9.391	13.245
10	1.669	3.999	6.924	9.332	13.030
15	1.672	4.001	6.900	9.278	12.828
20	1.675	4.005	6.881	9.229	12.638
25	1.678	4.010	6.865	9.184	12.460
30	1.683	4.016	6.853	9.143	12.293
35	1.688	4.024	6.844	9.106	12.137
40	1.693	4.033	6.838	9.072	11.991
45	1.700	4.044	6.834	9.041	11.855
50	1.707	4.057	6.833	9.013	11.728
55	1.715	4.071	6.837	8.964	11.609
60	1.724	4.086	6.841	8.942	11.499
65	1.733	4.103	6.847	8.922	11.396
70	1.744	4.122	6.854	8.903	11.301
75	1.755	4.142	6.861	8.885	11.213
80	1.766	4.163	6.984	9.455	11.130

pH calibration procedure

The following is an example of a three point pH calibration using auto-recognized pH 4.01, 7.00 and 10.01 pH buffers. The pH buffers can be read in any order. For this example, pH buffers are read lowest to highest.

1. In the pH measure mode, press the “Cal” key to start the pH calibration. The active Calibration Buffer Set is shown.



2. Rinse the pH/ATC electrode and place into the pH 4.01 buffer.
3. Wait for the pH value to stabilize.

- a. When the reading is unstable, the stopwatch icon is shown and the reading flashes.

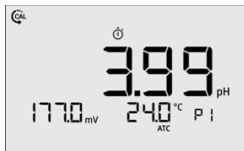

- b. When the reading is stable, the checkmark icon is shown and the reading is solid.

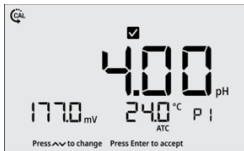

4. Once the reading is stable, press the “Enter” key. The meter will save the first calibration point and proceed to the next calibration point.



5. Rinse the pH/ATC electrode and place into the pH 7.00 buffer.

6. Wait for the pH value to stabilize.

- a. When the reading is unstable, the stopwatch icon is shown and the reading flashes.

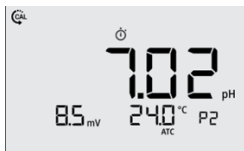

- b. When the reading is stable, the checkmark icon is shown and the reading is solid.



7. Once the reading is stable, press the “Enter” key. The meter will save the second calibration point and proceed to the next calibration point.



8. Rinse the pH/ATC electrode and place into the pH 10.01 buffer.

9. Wait for the pH value to stabilize.

- a. When the reading is unstable, the stopwatch icon is shown and the reading flashes.

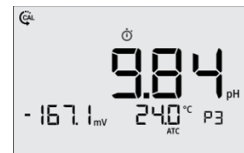

- b. When the reading is stable, the checkmark icon is shown and the reading is solid.



10. Once the reading is stable, press the “Enter” key. The meter will save the third calibration point.



11. Press the “Cal” key to end the calibration.

- a. The “Cal” key can be pressed when either the Saved or 4th Point screens is shown.



12. The average slope value is shown and then the Calibration Done screen is shown.

- a. The average slope is recommended to be between 92% to 102%.

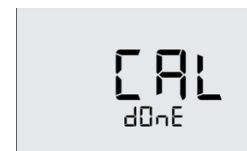

13. The meter will proceed to the main measure mode.

14. Store the pH/ATC electrode in electrode storage solution until ready for sample measurements.



Sample preparation

The sample preparation procedure should be customized for your specific sample types and requirements.

1. Add about 30 mL of the sample to a 50 mL beaker and label the beaker.
2. Repeat step 1 for additional samples.

Sample measurement overview

The Read Type selected in the meter Setup Menu will determine how measurements are performed and when measurements are saved to the data log and exported to an external device. Set the Read Type as Continuous, Auto-Read or Timed to define.

Continuous: In the Continuous measure mode, measurements are continuously updated on the display and the stopwatch (unstable) or checkmark (stable) icon indicates the measurement stability status. Press the “Log/Export” key to save a measurement to the data log and export to an external device.

Auto-Read: In the Auto-Read measure mode, press the “Measure” key to start a measurement. When the measurement is stable, the checkmark (stable) icon is shown and the measurement is locked on the display until the “Measure” key is pressed again. The stable measurement is automatically saved to the data log and exported.

Timed: In the Timed measure mode, the measurement values are continuously updated on the display. Measurements are automatically saved to the data log and exported at the selected time intervals, from 5 seconds to 60 minutes, the entire time the meter is in the measurement mode.

Sample measurement procedure

1. Once the calibration is complete, prepare the samples to be measured.
2. Rinse the pH/ATC electrode and place into the first sample solution.
3. Wait for the pH value to stabilize.
 - a. When the reading is unstable, the stopwatch icon is shown and the reading flashes.
 - b. When the reading is stable, the checkmark icon is shown and the reading is solid.
4. Once the reading is stable, record the sample pH and temperature values.
5. Remove the pH/ATC electrode from the sample.
6. Repeat steps 2-5 for all samples.
7. When all samples have been measured, store the equipment. For overnight storage, cover the fill hole and store the pH/ATC electrode in electrode storage solution.

Ordering Information

Type	Description	Cat. No.
Meters	Orion Lab Star PH111 pH/mV meter with stand, PC cable and universal power adapter	LSTAR1110
	Orion Lab Star PH111 pH/mV meter standard kit, includes meter with stand, PC cable, universal power adapter, 9157BNMD Triode 3-in-1 pH/ATC electrode, 916099 pH buffer and solution kit	LSTAR1115
Meter accessories	Orion Lab Star series electrode stand with meter-attached bracket	LSTAR-ARM
	Orion Lab Star series 100-240V 50/60Hz universal power adapter	LSTAR-PWR
	Orion Lab Star series USB computer cable	LSTAR-USB
	Orion Lab Star series meter dust cover	LSTAR-CVR
	Orion Star A series compact printer, ink ribbon, 100-240V, 50/60Hz	STARA-106
	Orion replacement ink ribbon for compact printer, 6 pack	STARA-108
	Orion replacement paper for compact printer, 5 pack	STARA-109
	Electrodes and accessories	Orion Triode 3-in-1 pH/ATC temperature electrode, refillable, epoxy-body, BNC and MiniDIN connectors, 1m cable
Orion general purpose pH electrode, refillable, glass-body, BNC, 1m cable		9102BNWP
Orion general purpose pH electrode, refillable, epoxy-body, BNC, 1m cable		9156BNWP
Orion epoxy automatic temperature compensation (ATC) probe, MiniDIN, 1m cable		927005MD
Orion stainless steel automatic temperature compensation (ATC) probe, MiniDIN, 1m cable		927007MD
Orion storage sleeve and base for 12 mm diameter electrodes		810017
Solutions	Orion pH 1.68 buffer bottle, 475 mL	910168
	Orion pH 4.01 buffer bottle, 475 mL	910104
	Orion pH 6.86 buffer bottle, 475 mL	910686
	Orion pH 7.00 buffer bottle, 475 mL	910107
	Orion pH 9.18 buffer bottle, 475 mL	910918
	Orion pH 10.01 buffer bottle, 475 mL	910110
	Orion pH 12.46 buffer bottle, 475 mL	910112
	Orion pH electrode storage solution, 475 mL	910001
	Orion Ag/AgCl single junction filling solution for Orion pH electrodes, 5 x 60 mL	900011
	Orion all-in-one standard pH buffer kit: 475 mL each of pH 4, 7 and 10 buffers and storage solution and electrode storage bottle	910199
Orion all-in-one 60 mL pH buffer kit: 60 mL each of pH 4, 7 and 10 buffers; storage solution and cleaning solution	916099	

Learn more at thermofisher.com/electrochemistry
 or email us at wlp.techsupport@thermofisher.com

thermo scientific