

Thermo Scientific Orion Star A329 Portable pH/ISE/Conductivity/RDO/DO Meter

Instruction Sheet

Preparation

Power Source

1. Power adapter (sold separately)
 - a. Select the appropriate wall socket plug plate.
 - b. Slide off the clear plastic cover from the plug plate.
 - c. Slide the plug plate into the groove on the back of the power adapter.
 - d. Connect the power adapter to the meter and power outlet.
2. Batteries (included with meter)
 - a. Select four AA alkaline batteries.
 - b. Confirm that the meter is powered off.
 - c. Remove the battery compartment cover – loosen the screws holding the battery cover, release the top portion of the battery cover from the meter (use a coin or your finger) and release the bottom portion of the battery cover.
 - d. Orientate the batteries as shown in the battery compartment housing and insert batteries.
 - e. Replace the battery compartment cover and screws.

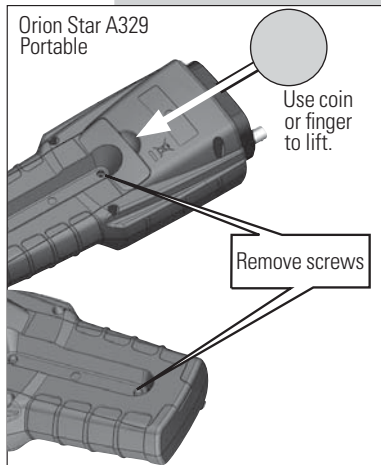

Electrodes and Other Connections

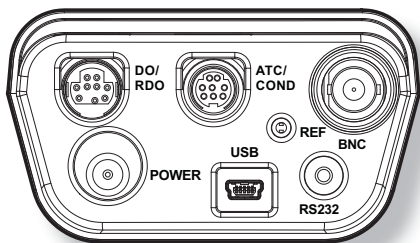

1. Prepare the pH electrode, ion selective electrode (ISE), conductivity cell, RDO optical dissolved oxygen probe, polarographic dissolved oxygen probe and any other applicable electrodes according to the directions in the electrode user guide.
2. Connect the appropriate items as labeled on the meter and as shown in the figure above:

For additional information on meter setup and operation, refer to the reference guide. The reference guide is on the included CD and available at www.thermoscientific.com/water.

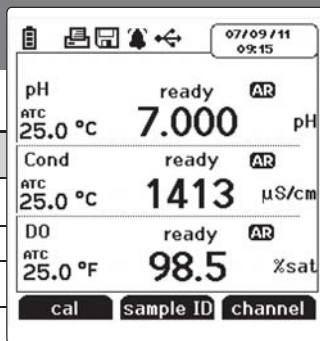

Display Information

Display Icon	Description
	Shown when the meter is running on AC power.
	Shown when the meter has batteries installed.
	Indicates data is being sent to a computer or printer.
	Indicates data is being sent to the data log.
	Shown when an alarm is set and the alarm value is reached.
	Indicates the meter is set to be interfaced with a printer or computer via the RS232 port.
	Indicates the meter is set to be interfaced with a printer or computer via the USB port.
	Displays the time and date entered in the setup menu.
	Displays the current temperature based on the temperature probe reading or entered temperature value. Shows the origin of the temperature as MAN (entered temperature) or ATC (temperature probe).
	Shown when is pressed and the displayed measurement is frozen.
	Indicates a calibration was successfully completed.
	Indicates the pH or ion selective electrode condition as good (two bars), fair (one bar) or bad (slash through it), based on the last saved calibration and measurement stability.
	Indicates a method is in use and the number of the method being used.
	Indicates the type of measurement and determines the type of calibration that will be performed.
	Specifies the stability of the electrode as stabilizing or ready .
	Shown when the meter is in AUTO-READ mode. The icon will blink while the reading is stabilizing and stop blinking when the reading is stable and the measurement is locked on the display.
	Displays the measurement value based on the last saved calibration and current electrode reading. Units are shown to the right of the value.
	Shows the raw millivolt reading of the electrode. pH and ISE modes only.
	Shows the buffer values used for the last saved calibration. pH mode only.
	Shows the standard values used for the last saved calibration. ISE mode only.
	Shows the cell constant in use from last saved calibration. Conductivity/TDS/Salinity/Resistivity modes only.
	Shows the barometric pressure measured by the meter (Auto) or entered by operator (Man.) and used to correct dissolved oxygen measurements. RDO/DO modes only.
	Displays the salinity correction factor used to correct dissolved oxygen measurements. RDO/DO modes only.
	Shows the operator assigned sample ID number.
	Shows the operator assigned user ID number.
	Displays the action that will be performed when f1 is pressed.
	Displays the action that will be performed when f2 is pressed.
	Displays the action that will be performed when f3 is pressed.

Keypad Display Information



Press the f1, f2 and f3 function keys to perform the action shown above each key on the display.



Press to turn the meter on.

When the meter is on, press and quickly release to turn the display backlight on or off or hold down to turn the meter off.



In the measurement mode, press to take a measurement.

In the setup, calibration and other menus, press to escape the current menu and return to the measurement mode.



In the measurement mode, press to enter the setup menu.

In the setup, calibration and other menus, press to scroll up through a list of options.



In the continuous measurement mode, press to freeze the displayed measurement and press again to unfreeze the measurement.

In the setup, calibration and other menus, press to scroll left through a list of options.



In the single channel measurement modes, press to change the displayed measurement mode. Options for channel 1 are pH, mV, RmV (relative mV), ORP and ISE. Options for channel 2 are Cond (conductivity), TDS, Salinity and Res (resistivity). Options for channel 3 are %sat (dissolved oxygen in percent saturation), mg/L (dissolved oxygen in milligrams per liter) or °C (probe membrane temperature).









In the setup, calibration and other menus, press to scroll right through a list of options.



In the measurement mode, press to log or print a measurement.

In the setup, calibration and other menus, press to scroll down through a list of options.







Keypad

1. Press  to power the meter on. When the meter is on, press and quickly release  to turn the backlight on or off or press and hold  for about three seconds to power the meter off.
2. Press  to exit any meter function and return to the measurement mode.
3. The **f1**, **f2**, and **f3** function keys perform a variety of meter operations. The menu-specific operation is shown above each key. For example, press **f1** in the measurement mode to start a calibration.
4. The , ,  or  keys are used as navigation keys (up, right, down, left) when selecting from a fixed list or grid of meter options. In the measurement mode, these keys are used to access the setup menu, change the measurement mode, manually log or print a measurement and hold (freeze) a displayed measurement.

pH and ISE Calibration

One to five pH buffers can be used for calibration. Always use fresh pH buffers and select buffers that bracket the sample pH and are one to four pH units apart. Prepare the pH electrode according to the instructions in the electrode use guide. Connect the pH electrode and any other electrodes to be used (ATC probe, reference electrode) to the meter. Power on the meter and set the measurement mode to pH.

One to five standards can be used for ISE calibration. If more than one standard is used to calibration, start with the lowest concentration standard and work up to the highest concentration standard last. Always use fresh standards. Select standards that bracket the sample concentration and are a decade apart in concentration. Prepare the ion selective electrode according to the instructions in the electrode use guide. Connect the ISE and any other electrodes to be used (ATC probe, reference electrode) to the meter. Power on the meter and set the measurement mode to ISE.







1. In the measurement mode, press **f1 (cal)**. Press  or  to highlight *pH-Channel* and press **f2 (select)**.
2. Rinse the pH or ion selective electrode and any other electrodes in use with distilled water, blot dry with a lint-free tissue and place into the pH buffer or ISE standard.
3. When the electrode and buffer or standard are ready, press **f3 (start)**.
4. Wait for the pH or concentration value on the meter to stabilize and stop flashing and perform one of the following actions:
 - a. Press **f2 (accept)** to accept the displayed value.
 - b. Press **f3 (edit)** to access the numeric entry screen and edit the value.
 - i. Press , ,  or  to highlight a number, decimal point or negative sign; press **f3 (enter)** to select the highlighted item and repeat until the value at the measured temperature is shown above the numeric entry screen.
 - ii. Press **f2 (done)** to exit the numeric entry screen.
 - iii. Press **f2 (accept)** to accept the entered value.
5. Press **f2 (next)** to proceed to the next buffer or standard and repeat steps 2 through 4 or press **f3 (cal done)** to save and end the calibration. If five buffers or standards are used, the calibration will save and end once the fifth value is accepted.
 - a. If a one point calibration is performed, press **f2 (accept)** to accept the displayed slope value or press **f3 (edit)** to access the numeric entry screen, enter the slope value and press **f2 (accept)**.
6. The meter will display the calibration summary including the average slope. Press **f1 (meas)** to export the data to the calibration log or press **f2 (print)** to export the data to the calibration log and a printer or computer. The meter will automatically proceed to the measurement mode.

Conductivity Calibration

One to five conductivity standards can be used for calibration. Always use fresh standards and select standards that are near the sample conductivity. Prepare the conductivity cell according to the instructions in the conductivity cell use guide. Connect the conductivity cell and any other electrodes to be used to the meter. Power on the meter and set the measurement mode to conductivity.

Note: For an automatic calibration, the nominal cell constant of the conductivity cell must be entered in the setup menu before the calibration is performed and Thermo Scientific Orion 100 $\mu\text{S}/\text{cm}$, 1413 $\mu\text{S}/\text{cm}$ and/or 12.9 mS/cm conductivity standards must be used.

Automatic and Direct Calibration





1. In the measurement mode, press **f1 (cal)**. Press  or  to highlight **Conductivity-Channel** and press **f2 (select)**.
2. Rinse the conductivity cell and any other electrodes in use with distilled water, blot dry with a lint-free tissue and place into the standard.
3. When the conductivity cell and standard are ready, press **f3 (start)**.
4. Wait for the conductivity value on the meter to stabilize and stop flashing and perform one of the following actions:
 - a. Press **f2 (accept)** to accept the displayed conductivity value.
 - b. Press **f3 (edit)** to access the numeric entry screen and edit the conductivity standard value.
 - i. Press , ,  or  to highlight a number or decimal point, press **f3 (enter)** to select the highlighted item and repeat until the standard value at the measured temperature is shown.
 - ii. Press **f2 (done)** to exit the numeric entry screen.
 - iii. Press **f2 (accept)** to accept the entered conductivity value.
5. Press **f2 (next)** to proceed to the next standard and repeat steps 2 through 4 or press **f3 (cal done)** to save and end the calibration. If five standards are used, the calibration will save and end once the fifth conductivity standard value is accepted.
6. The meter will display the calibration summary including the average calculated cell constant. Press **f1 (meas)** to export the data to the calibration log or press **f2 (print)** to export the data to the calibration log and a printer or computer. The meter will automatically proceed to the measurement mode.

RDO/DO Calibration

Polarographic DO probes only - A polarographic DO probe must be polarized. The probe is continuously polarized when it is connected to the meter. If the probe is not connected to the meter: connect the probe to the meter, connect the meter to a power source and wait 30 to 60 minutes for polarization.





The Orion Star A329 meter can perform a calibration using water-saturated air (*Air*), air-saturated water (*Water*), Winkler titration (*Manual*) or zero point calibration (*Set Zero*). See the reference guide for detailed instructions for each calibration.

Air Calibration

1. In the measurement mode, press **f1 (cal)**. Press  or  to highlight *DO-Channel* and press **f2 (select)**.
2. Press  or  to highlight *Air* and press **f3 (select)**.
3. Rinse the RDO optical DO probe or polarographic DO probe with distilled water, blot dry with a lint-free tissue and place into the prepared calibration sleeve or BOD bottle. Allow the probe and water-saturated air to reach equilibrium.
4. When the probe and water-saturated air are ready, press **f3 (start)**.
5. Wait for the dissolved oxygen reading on the meter to stabilize and stop flashing. Once the reading is stable, the meter will display *Accepting Auto % Sat. Calibration* and *100.0 %* if using an RDO optical DO probe or *102.3 %* if using a polarographic DO probe.
6. Press **f3 (cal done)** to export the data to the calibration log or press **f2 (print)** to export the data to the calibration log and a printer or computer. The meter will proceed to the measurement mode.

Set Zero Calibration

A zero point calibration is performed in an oxygen-free solution. A zero point calibration is not generally required unless measurements will be taken below 10% saturation or 1 mg/L. Perform an air or water calibration before performing a zero point calibration.



1. In the measurement mode, press **f1 (cal)**. Press  or  to highlight *DO-Channel* and press **f2 (select)**.
2. Press  or  to highlight *Set Zero* and press **f3 (select)**.
3. Rinse the RDO optical DO probe or polarographic DO probe and any other electrodes in use with distilled water, blot dry with a lint-free tissue and place into the prepared zero oxygen standard. Allow the probe and standard to reach equilibrium.
4. When the probe and zero oxygen standard are ready, press **f3 (start)**.
5. Wait for the dissolved oxygen reading on the meter to stabilize and stop flashing. Once the reading is stable, the meter will display *Accepting Auto % Sat. Calibration* and *0.00*.
6. Press **f3 (cal done)** to export the data to the calibration log or press **f2 (print)** to export the data to the calibration log and a printer or computer. The meter will proceed to the measurement mode.



Measurement

The Orion Star A329 meter is capable of showing three measurements simultaneously on the display. The first channel can be set to measure pH, mV, RmV (relative mV), ORP or ISE. The second channel can be set to measure Cond (conductivity), TDS, Salinity or Res (resistivity). The third channel can be set to measure DO -%sat (dissolved oxygen in percent saturation), DO - mg/L (dissolved oxygen in milligrams per liter) or DO -°C (probe membrane temperature).













The meter can be set to display one, two or all three of these measurement channels, depending on the operator's needs. In the measurement mode, press **f3 (channel)** to scroll through a single measurement display of channel one, two or three; a dual measurement display of channel one and two, two and three or three and one; and a multi measurement display of channel one, two and three. To change the measurement mode of a channel, press **f3 (channel)** until the single measurement display of that channel is shown and then press  until the correct mode is shown.

Note: It is highly recommended that any unused channels not be shown on the meter display while taking measurements, since the meter waits for all displayed channels to stabilize before logging the measurement data.

Press  while taking a measurement in the continuous measurement mode to freeze the display and press  a second time to unfreeze the display and continue the measurement. Press  while taking a measurement to manually export the measurement to the data log, if the data log is enabled in the setup menu.















1. Rinse the pH electrode or ion selective electrode (ISE), conductivity cell, RDO optical dissolved oxygen probe or polarographic dissolved oxygen probe and any other electrodes in use with distilled water, blot dry with a lint-free tissue and place into the sample.
2. Start the measurement and wait for it to stabilize.
 - a. If the meter is in **AUTO-READ** mode (default setting), press  to start the measurement. When the **AR** icon stops flashing, record the applicable measurement parameters and temperature of the sample. Press  again to start a new measurement.
 - b. If the meter is in continuous mode, the meter will immediately start taking a measurement and update the display whenever the measurement changes. Wait for the display to show **ready** and record the applicable measurement parameters and temperature of the sample.
 - c. If the meter is in timed mode, the meter will log measurements at the preselected time interval, regardless of the measurement stability. The meter will update the display whenever the measurement changes, so the applicable measurement parameters and temperature of the sample can be recorded when the display shows **ready**.
3. Remove the electrodes from the sample, rinse with distilled water, blot dry and place into the next sample.
4. Repeat steps 2 and 3 for all samples.
5. When all samples have been measured, store the electrodes according to their user guides.

Read Type Selection

1. In the measurement mode, press .
2. Press , ,  or  to highlight *pH Channel*, *COND Channel*, or *DO Channel* and press **f3 (select)**.
3. Press  or  to highlight *Mode and Settings* and press **f3 (select)**.
4. Press  or  to highlight *Read Type* and press **f3 (select)**.
5. Press  or  to highlight *Auto*, *Continuous* or *Timed* and press **f3 (select)**.
 - a. If *Timed* is selected and the time interval needs to be changed – highlight *Timed*; press  to highlight hours (HH), minutes (MM) or seconds (SS); press **f3 (edit)** to access the numeric entry screen; use the numeric entry screen to change the values and press **f1 (back)** when the time interval is correct.
6. Press  to return to the measurement mode.

Setup Menu

Navigating the Setup Menu













1. In the measurement mode, press  to enter the main setup menu.
2. Press , ,  or  to scroll through the main setup menu options. Press **f3 (select)** to select a main setup menu option.
3. Press  or  to scroll through setup submenu options. Press **f3 (select)** to select a setup submenu option.
4. Perform the appropriate actions to set the desired parameter in the setup submenus.
 - a. To select a value from a list of options, press  or  to highlight the desired value and press **f3 (select)** to set the value.
 - b. To enter a numeric value, use the numeric entry screen.
 - i. Select the value to be entered by pressing **f3 (select)** or **f3 (edit)**. The numeric entry screen will popup on the display.
 - ii. Press , ,  or  to highlight a number, decimal place or negative sign; press **f3 (enter)** to select the highlighted item and repeat until the desired value is shown on the top of the numeric entry screen.
 - iii. Press **f2 (done)** to save the value and exit the numeric entry screen.
5. Press **f1 (back)** and then  to return to the measurement mode at any time.

Setup Menu Overview













pH Channel	COND Channel	DO Channel	Settings	Log View	Diagnostics
<p>Method</p> <hr/> <p>Mode & Settings</p> <ul style="list-style-type: none"> • Measure Mode • Read Type • Resolution • Buffer Group (pH) <p>or</p> <ul style="list-style-type: none"> • Measure Unit (ISE) • Stability • Averaging • Temp Comp • Temp Coeff • Alarm Settings <hr/> <p>Temperature</p> <ul style="list-style-type: none"> • Manual Temp Value • Temperature Unit • Temperature Calibration • Temperature Input 	<p>Method</p> <hr/> <p>Mode & Settings</p> <ul style="list-style-type: none"> • Measure Mode • Read Type • Cell K • Stability • Averaging • Ref Temp • Temp Comp. • Temp Coeff • Alarm Settings <hr/> <p>Temperature</p> <ul style="list-style-type: none"> • Manual Temp Value • Temperature Unit • Temperature Calibration • Temperature Input 	<p>Method</p> <hr/> <p>Mode & Settings</p> <ul style="list-style-type: none"> • Measure Mode • Measure Unit • Resolution • Read Type • Baro Press • Salinity Correct • Stability • Averaging • Alarm Settings <hr/> <p>Temperature</p> <ul style="list-style-type: none"> • Manual Temp Value • Temperature Unit • Temperature Calibration • Temperature Input 	<ul style="list-style-type: none"> • Export Data • Data Log • Date / Time • Language • Key Press Beep • Alarm Beep • Contrast • Auto Shut Off • User ID • Sample ID 	<ul style="list-style-type: none"> • Data Log • Calibration Log 	<ul style="list-style-type: none"> • Meter Self Test • Factory Reset • About Meter

pH Buffer Group Selection

The selected buffer group allows for the automatic recognition of certain pH buffers during a pH calibration. The USA buffer group includes pH 1.68, 4.01, 7.00, 10.01 and 12.46 buffers and the DIN buffer group includes pH 1.68, 4.01, 6.86, and 9.18 buffers.













1. In the measurement mode, press .
2. Press , ,  or  to highlight **pH Channel** and press **f3 (select)**.
3. Press  or  to highlight **Mode and Settings** and press **f3 (select)**.
4. Press  or  to highlight **Buffer Group** and press **f3 (select)**.
5. Press  or  keys to highlight **USA** or **DIN** and press **f3 (select)**.
6. Press  to return to the measurement mode.

ISE Measurement Unit Selection

1. In the measurement mode, press .
2. Press , ,  or  to highlight *pH Channel* and press **f3 (select)**.
3. Press  or  to highlight *Mode and Settings* and press **f3 (select)**.
4. Press  or  to highlight *Measure Unit* and press **f3 (select)**.
5. Press  or  to highlight *ppm, M, mg/L, percentage (%), ppb* or *None* and press **f3 (select)**.
6. Press  to return to the measurement mode.















ISE Automatic Blank (Non-Linear) Correction Selection

The automatic blank correction feature uses an algorithm to compensate for the non-linearity of an ion selective electrode in low level standards and samples. The meter determines whether blank correction is the best measurement strategy by analyzing the electrode response during a calibration with at least three calibration points. The average slope displayed when using this feature may be outside the slope range specified in the electrode user guide due to the set of non-linear equations used to calculate the blank correction.

1. In the measurement mode, press .
2. Press , ,  or  to highlight *pH Channel* and press **f3 (select)**.
3. Press  or  to highlight *Mode and Settings* and press **f3 (select)**.
4. Press  or  to highlight *Blank Correct* and press **f3 (select)**.
5. Press  or  to highlight *Yes* or *No* and press **f3 (select)**.
6. Press  to return to the measurement mode.













Conductivity Nominal Cell Constant Entry

The nominal cell constant value is used during an automatic conductivity calibration and allows the meter to determine which Thermo Scientific Orion conductivity standard is being used for the calibration.

1. In the measurement mode, press .
2. Press , ,  or  to highlight *COND Channel* and press **f3 (select)**.
3. Press  or  to highlight *Mode and Settings* and press **f3 (select)**.
4. Press  or  to highlight *Cell K* and press **f3 (select)**.
5. Press **f3 (select)** to access the numeric entry screen and enter the nominal cell constant of the conductivity cell.
 - a. Press , ,  or  to highlight a number or decimal point, press **f3 (enter)** to select the highlighted item and repeat until the nominal cell constant value is shown.
 - b. Press **f2 (done)** to exit the numeric entry screen.
6. Press **f1 (back)** and then press  to return to the measurement mode.













Conductivity Reference Temperature Selection

The reference temperature is the temperature that all conductivity measurements will be reported at by the meter if temperature compensation is enabled.

1. In the measurement mode, press .
2. Press , ,  or  to highlight *COND Channel* and press **f3 (select)**.
3. Press  or  to highlight *Mode and Settings* and press **f3 (select)**.
4. Press  or  to highlight *Ref Temp.* and press **f3 (select)**.
5. Press  or  to highlight *5 °C, 10 °C, 15 °C, 20 °C or 25 °C* and press **f3 (select)**.
6. Press  to return to the measurement mode.













Conductivity Temperature Compensation Selection

The temperature compensation can be turned off or set to Linear, nLFn (non-linear ultra pure non-degassed water), nLFu (non-linear ultra pure degassed water) or EP (temperature compensation off and warning is displayed if conductivity values are outside EP requirements for ultra pure water) and is used to report all conductivity measurements at the selected reference temperature.















1. In the measurement mode, press .
2. Press , ,  or  to highlight *COND Channel* and press **f3 (select)**.
3. Press  or  to highlight *Mode and Settings* and press **f3 (select)**.
4. Press  or  to highlight *Temp. Comp.* and press **f3 (select)**.
5. Press  or  to highlight *Off, Linear, nLFn, nLFu or EP* and press **f3 (select)**.
6. Press  to return to the measurement mode.

DO Probe Type Selection













The Orion Star A329 meter accepts and automatically recognize Orion RDO optical dissolved oxygen probes and Orion polarographic dissolved oxygen probes. If a different probe is used or the probe type needs to be verified, perform the following steps.

1. In the measurement mode, press .
2. Press , ,  or  to highlight *DO Channel* and press **f3 (select)**.
3. Press  or  to highlight *Mode and Settings* and press **f3 (select)**.
4. Press  or  to highlight *Measure Mode* and press **f3 (select)**.
5. Press  or  to highlight *DO* (polarographic probe) or *RDO* (RDO optical probe) and press **f3 (select)**.
6. Press  to return to the measurement mode.

Viewing the Calibration Log

1. In the measurement mode, press .
2. Press , ,  or  to highlight *View Log* and press **f3 (select)**.
3. Press  or  to highlight *Calibration Log* and press **f2 (accept)**.
4. Press  or  to highlight *pH – Channel, Conductivity – Channel* or *DO – Channel* and press **f2 (select)**.
5. Press  or  to highlight *pH, RmV, ORP* or *ISE* (pH - Channel); *Conductivity, Resistivity, TDS*, or *Salinity* (Conductivity - Channel); *DO* or *RDO* (DO- Channel) and press **f2 (select)**.
6. The meter will display a list of calibrations for the selected channel and calibration type. The list shows the sequential number of the calibration and the date and time it was saved (*07/01/2011 12:45*).
7. To view the calibration data, press  or  to highlight a specific calibration and press **f2 (select)**. Press **f2 (print)** to print the calibration, press **f3 (info)** to view the electrode slope between pH buffer or ISE standard points (pH - Channel only) or press **f1 (back)** to return to the list of calibrations.
8. Press  to return to the measurement mode.

Viewing the Data Log

1. In the measurement mode, press .
2. Press , ,  or  to highlight *View Log* and press **f3 (select)**.
3. Press  or  to highlight *Data Log* and press **(accept)**.
4. Press  or  to highlight *pH - Channel, Conductivity - Channel* or *DO - Channel* and press **f2 (select)**.
5. The meter will display a list of the data points. The list shows the sequential number of the data point and the date and time the data point was saved (*07/01/2011 12:45*).
6. To view the measurement information for an individual data point, press  or  to highlight the data point and press **f2 (select)**. Press **f2 (print)** to print the data point or press **f1 (back)** to return to the list of data points.
7. Press  to return to the measurement mode.